



Midwest
Designer
Supply

1-888-523-2611

customer.service@midwestdesignersupply.com



AMP™ Motorization

LIVING

Smart

Finally, control your draperies in an instant from anywhere with our new AMP™ Motorization. Enjoy the ease and comfort of motorized draperies on our most popular rods. Our quiet yet powerful motor moves on command and whisks your draperies in an instant so you can experience comfortable living at its finest. Now that's a smart move.



CONTENTS

01\ Overview

03\ AMP™ Motorization

07\ Architrac® + AMP™

09\ 1³/₈" Estate™ + AMP™

11\ 2" Estate™ + AMP™

13\ Estate™ Mounting Options

16\ Warranty

OVERVIEW & BENEFITS

Why AMP™?

The slim design of the quiet, yet powerful motor and the position on the track allows the motor to tuck seamlessly behind your drapery panel so you'll never have to sacrifice your style or comfort. For safety measures, you're able to move the draperies with a gentle tug, allowing for operation when a remote is not present or if a guest is unaware of the motorization feature. The dual battery and AC power sources allows operation in case of a power outage so draperies may be opened in the event of an emergency. AMP™ Motorization is available on our most popular traversing tracks, Estate and Architrac® Series 94001 and in drapery header styles Ripplefold™ and pleated for a variety of styling options. This is comfortable living at its finest.

For AMP™ Motorization brochure, programming instructions and installation instructions, please visit the drapery hardware resource library at kirsch.com.

Benefits & Features

AMP™ Motorization

- Motor mounts to the back of the track which allows a seamless look between motorized and manual traverse rods
- Drapery fabrication does not need to change between manual controlled draperies and motorized draperies; No additional returns or any special instructions
- Limits are set automatically after installation
- Remote control is radio frequency and easily pairs with the motor
- Tug feature; when drapery is pulled the motor will traverse the drapery
- AMP™ App with AMP™ USB Bridge
- Architrac® Series 94001 Rods with AMP™ cannot be bent or curved

Frequently Asked Questions

What is the weight capacity?

64 lbs Motor is rated to 64 lbs. Be sure not to exceed the Estate or Architrac track specifications to ensure your motor operates optimally.

Can you double the weight capacity by using two motors?

No Only use one motor per rod.

Does AMP™ offer limit setting?

Yes The motor automatically sets its limits.

Does AMP™ offer touch control?

Yes The tug feature allows you to pull on the drapery and the motor will automatically open or close your draperies.

How long is the power cord?

6 ft The durable power cord is extra long for out of reach places. Any extra can be rolled and secured for a tidy look. Cable extensions are available in 15', 4', 10' and 20' lengths to reach outlets that are farther away from the motor.

Is there a wall switch?

Yes There are Flush Mount and Surface Mount Wall Switches available.

Does AMP™ offer a warranty?

Yes See the Kirsch Warranty document for more information.

AMP™ Motorization at a Glance

To help determine which system is right for your project, use the guideline below to select the best fit. For more detailed information about each track, please visit our resource library at kirsch.com.

AMP™ MOTORIZATION TRACK STYLES	BUCKINGHAM® ESTATE™	DESIGNER METALS™ ESTATE™	WOOD TRENDS™ ESTATE™	WROUGHT IRON ESTATE™	CHROMA ESTATE™	VARIA ESTATE™	ARCHITRAC® 94001
What is your preferred size?							
1⅜ inch	•	•	•	•	N/A	N/A	N/A
2 inch	•	•	•	•	•	•	N/A
What is the preferred Drapery Heading type?							
Pleated	•	•	•	•	•	•	•
Ripplefold™	•	•	•	•	•	•	•
What is your mounting location?							
Ceiling Mount*	•	•	•	•	•	•	•
Wall Mount	•	•	•	•	•	•	•
Recessed Mount*	N/A	N/A	N/A	N/A	N/A	N/A	•
What is your preferred look?							
With rings (2" Estate™ only)	•	•	N/A	N/A	N/A	N/A	N/A
Without rings	•	•	•	•	•	•	N/A

* Finial choices may be limited for ceiling mounted Estate™ Rods.

Master Carriers

DRAW	Overlap Master	Butt Master
ONE-WAY	•	•
TWO-WAY	•	•

Estate™ Track Performance with AMP™

DRAW	MINIMUM TRACK LENGTH	MAXIMUM TRACK LENGTH	MAXIMUM FABRIC WEIGHT	MAX. LBS. PER FOOT
ONE-WAY	18"	16'	64 LBS.	4 LBS.
TWO-WAY	18"	16'	64 LBS.	4 LBS.

Architrac® Track Performance with AMP™

DRAW	MINIMUM TRACK LENGTH	MAXIMUM TRACK LENGTH	MAXIMUM FABRIC WEIGHT*	MAX. LBS. PER FOOT*
ONE-WAY	18"	16'	64 LBS.	4 LBS.
TWO-WAY	18"	16'	64 LBS.	4 LBS.



* For AMP™ Only.

AMP™ MOTORIZATION

Motorization System

- Soft start/stop & manual operation
- Tug feature; when drapery is pulled the motor will traverse the drapery
- Automatic limits on end stop
- Favorite/intermediate position available
- Dry contact for external control
- RF Remote and Wall Switches
- Setting with buttons on motor unit
- Setting with external dry contact switch
- LED Indicators
- One-Way and Two-Way Draw
- Pleated
- Ripplefold™
- AMP™ App with AMP™ USB Bridge

Additional Information

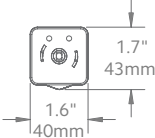
SIDE VIEW	FRONT VIEW	BOTTOM VIEW	MOTORIZED TRACK FEATURES	AMP™ MOUNT																				
 <p>16.3" 410mm</p>	 <p>Ht. w/ track 17.4" 443mm</p>	 <p>1.6" 40mm 1.7" 43mm</p>	<table border="1"> <tr> <td>Power Supply</td> <td>DC 16.5V=0.89A (100-240VAC 50/60Hz 0.5A)</td> </tr> <tr> <td>Amperage</td> <td>2.55Ah</td> </tr> <tr> <td>Average Linear Speed</td> <td>7.8 inches/sec</td> </tr> <tr> <td>Power Consumption</td> <td>40 watts</td> </tr> <tr> <td>Torque</td> <td>1.2Nm</td> </tr> <tr> <td>Variable Speed</td> <td>80, 100 & 120 rpm</td> </tr> <tr> <td>Power Cable Length</td> <td>6 feet</td> </tr> <tr> <td>Certifications</td> <td>UL/CE</td> </tr> <tr> <td>Max Track Length</td> <td>Estate™ – 16ft Architrac® 94001 – 16ft</td> </tr> <tr> <td>Max. Load</td> <td>64 lbs</td> </tr> </table>	Power Supply	DC 16.5V=0.89A (100-240VAC 50/60Hz 0.5A)	Amperage	2.55Ah	Average Linear Speed	7.8 inches/sec	Power Consumption	40 watts	Torque	1.2Nm	Variable Speed	80, 100 & 120 rpm	Power Cable Length	6 feet	Certifications	UL/CE	Max Track Length	Estate™ – 16ft Architrac® 94001 – 16ft	Max. Load	64 lbs	
Power Supply	DC 16.5V=0.89A (100-240VAC 50/60Hz 0.5A)																							
Amperage	2.55Ah																							
Average Linear Speed	7.8 inches/sec																							
Power Consumption	40 watts																							
Torque	1.2Nm																							
Variable Speed	80, 100 & 120 rpm																							
Power Cable Length	6 feet																							
Certifications	UL/CE																							
Max Track Length	Estate™ – 16ft Architrac® 94001 – 16ft																							
Max. Load	64 lbs																							

Follow track specifications for drapery weight.

Download the AMP™ APP to get started



Need assistance with your AMP™ Motor?













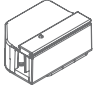

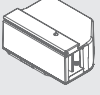

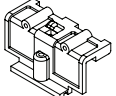

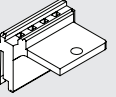
If you are an end-user, please contact your installer or dealer.

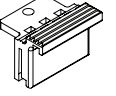
If you are a dealer or distributor, for specialized AMP Technical Support, please contact us by phone at (800) 252-2512 or by email at amp@turnils.com.

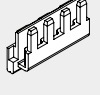

AMP™ MOTORIZATION

Component Overview

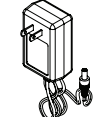
ITEM	PRODUCT NUMBER & FINISH	DESCRIPTION	ITEM	PRODUCT NUMBER & FINISH	DESCRIPTION
	62001300 White	AMP Motor RF 2W DC Drapery Motor 1.2Nm-20cm 14.8V		62102000 White	AMP Gateway USB Bridge
	84531025 White	AMP Drapery Motorhead Adapter Right		84509061	Adjustable Pulley Right
	84532025 White	AMP Drapery Motorhead Adapter Left		84508061	Adjustable Pulley Left
	84503025 White 84503059 Black	Drapery Motor Master Carrier Adapter		62109000 White	AMP Wall Switch Surface RF 2W 15 Channel
	84504025 White	Drapery Motor Belt Connector Front		62108000 White	AMP Wall Switch RF 2W 15 Channel
	84505025 White	Drapery Motor Belt Connector Back		2989899000	15" Cable Assembly
	84506025 White	Drapery Motor Belt Connector Clip		1026661	4' Cable Assembly
	84510000	Motor Belt		2989901000	10' Cable Assembly
	62101000 White 62101010 Black	Remote Control 5 Channels		2989902000	20' Cable Assembly
	62201300 White	AMP Battery Charger 16.5V/0.89A			



Connect your AMP™ motor to the AMP™ USB Bridge for the ultimate control in creating your smart home.

ARCHITRAC® WITH AMP™

A Moving Performance

Architrac® Series 94001 is the most versatile rod in the Architrac® lineup and now with AMP™ Motorization on board, this rod has become the ultimate powerhouse. With your choice of hardware colors and drapery header styles you can completely customize this rod to your specifications. Perfect for homes, businesses or other commercial drapery applications, Architrac® will glide through your most demanding applications with ease.

Available Track Colors

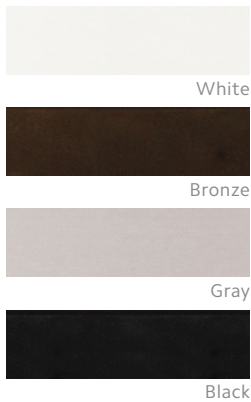

Additional Information

For more detailed information about this track, please visit our resource library at kirsch.com.

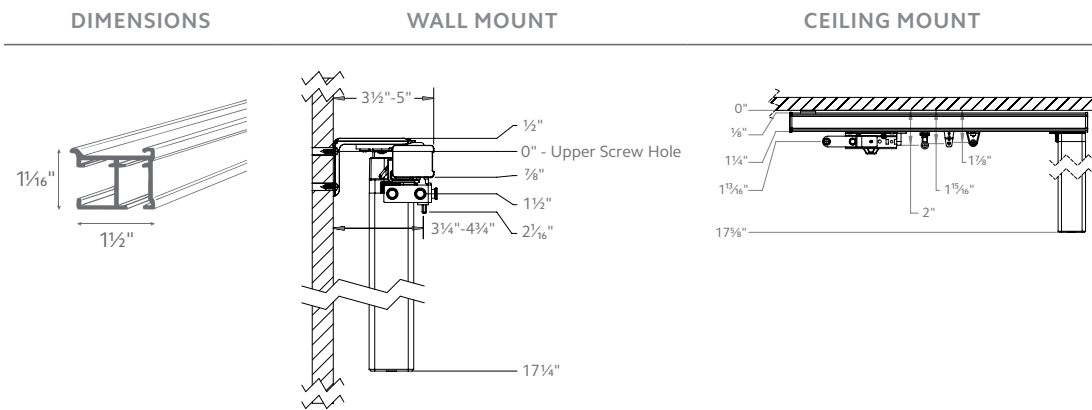

DRAW	MOUNT	MAXIMUM TRACK SET	MAXIMUM FABRIC WEIGHT	MAX. LBS. PER FOOT
ONE-WAY	CEILING WALL RECESSED	16'	64 LBS.	4 LBS.
TWO-WAY	CEILING WALL RECESSED	16'	64 LBS.	4 LBS.





ARCHITRAC®
SERIES 94001
WITH SLIDES
Shown in white.
Custom sizes only.

1 3/8" ESTATE™ WITH AMP™

Small but Mighty

The 1 3/8 inch Estate™ rods are our newest decorative traversing drapery rods. Available in our Buckingham®, Designer Metals™, Wood Trends™ and Wrought Iron collections, this new smaller size is perfect for smaller spaces while still providing high performing function. The rod may be smaller, but the style is still bold. You can pair any of the 1 3/8 inch finials to complete your design so you never have to sacrifice your brilliant style for performance.

Available Colors

Buckingham®



Moonglow



Camden



Distressed Oak

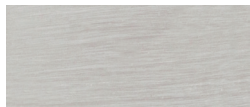

Winterwood



Sterling



Shimmer



Castle Rock

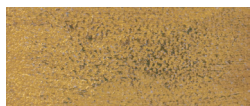

Ornate



Old World White

Designer Metals™



Polished Nickel

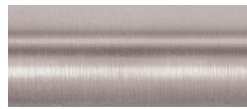

Satin Nickel



Antique Silver



Black**



Brushed Bronze



Gilded Bronze

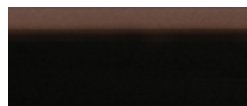

Caramel

*Select finishes are color coordinated. Refer to price guide for details.

Wood Trends™



White



Marble



Truffle

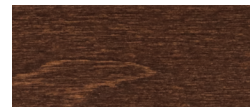

Coffee



Estate Oak



Mahogany



Dark Chocolate



Black



Unfinished

Wrought Iron



Chalk

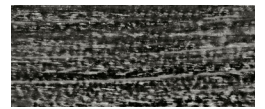

Graphite



Heirloom Copper

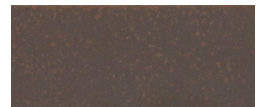

Rust

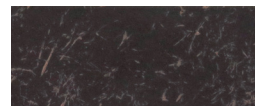

Iron Oxide

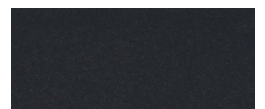

Black



DESIGNER METALS™
1 3/8" ESTATE™ ROD
WITH PLEATED CARRIERS
Shown in Satin Nickel
with Endcap.

2" ESTATE™ WITH AMP™

Evolving the Standard

2 inch Estate™ rods are our standard decorative traversing drapery rods with wheeled carriers that are designed to carry today's heavier draperies. Having set the interior design standard for decades, each of the Estate™ collections are characterized by inspired finials, premium finishes, and precision engineered components. Buckingham®, Designer Metals™, Wood Trends™, Varia and Chroma Collections are featured in countless luxury venues and designer homes throughout the world.

Available Colors

Buckingham®



Moonglow

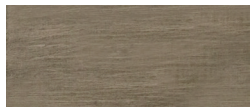

Camden

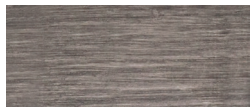

Distressed Oak



Winterwood



Sterling

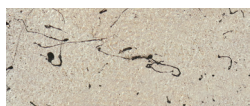

Shimmer



Castle Rock

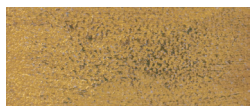

Ornate



Old World White

Designer Metals™



Polished Nickel

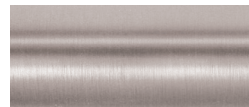

Satin Nickel



Antique Silver

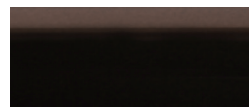

Oil Rubbed Bronze*



Black**



Brushed Bronze



Gilded Bronze

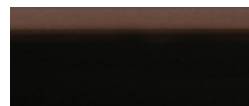

Caramel

*Oil Rubbed Bronze with rings uses Black pole with Oil Rubbed Bronze rings.
 **Select finishes are color coordinated. Refer to price guide for details.

Wood Trends™



White

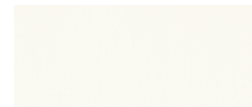

Marble



Truffle

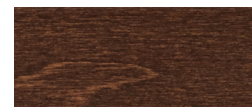

Coffee



Estate Oak



Mahogany



Dark Chocolate



Black



Unfinished

Chroma



Vellum Reflect



Lemon Reflect



Smudge



Rockport

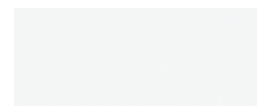

Vellum



Cityscape



Cayman



Mythical



Jello



Varia



Clementine



Citron



Lapis



Pure Gold



Pure Silver

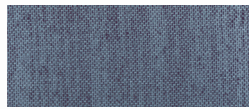

Hem Thames

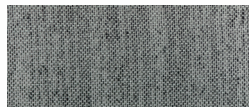

Hem Tetons



Hem Ashland

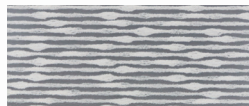

Flock Cotton 2



Connection Mini Pure

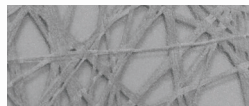

Connection Mini Gray

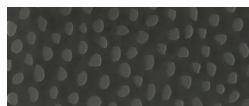

Hint Spotted



Fray Baltic

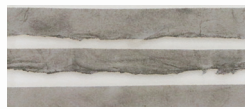

Fray Smoke

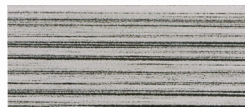

Strand White



VARIA
2" ESTATE™ ROD

Shown in Hem Thames
Custom sizes only.

ESTATE™ MOUNTING OPTIONS

Bracket Spacing

Place bracket at each end, place next bracket 24" from first, then place remaining brackets at 48" intervals over the remainder of the track. Spacing may need to be shortened for heavier draperies. All mounting options are compatible with our AMP™ Motorization.



USING 94129061, 1856973, 1856978 or 1857324

1 3/8" WALL MOUNT

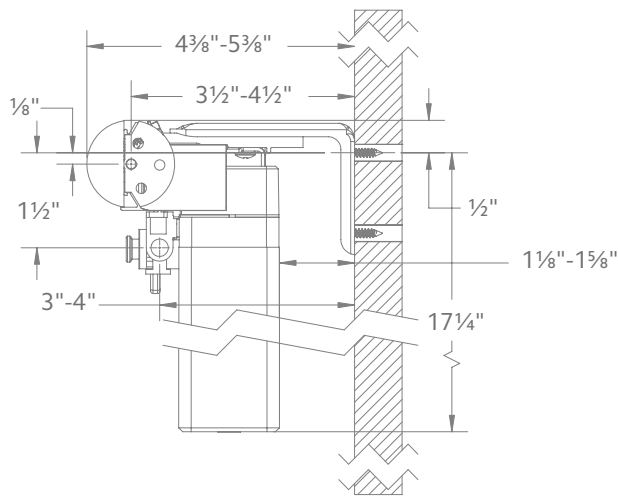

2" WALL MOUNT

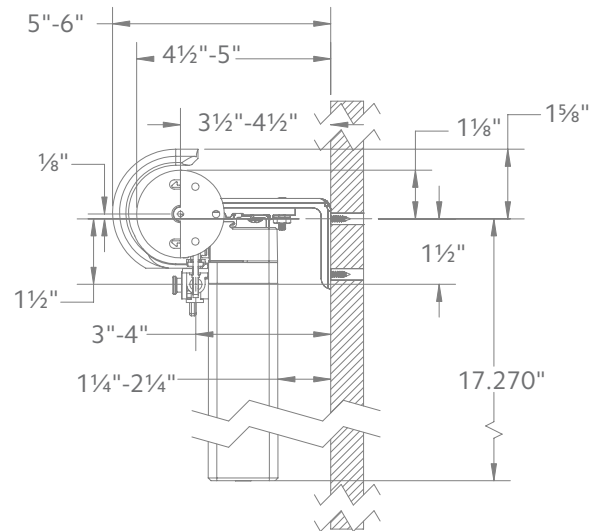

USING 94130xxx and 1796061

1 3/8" CEILING MOUNT

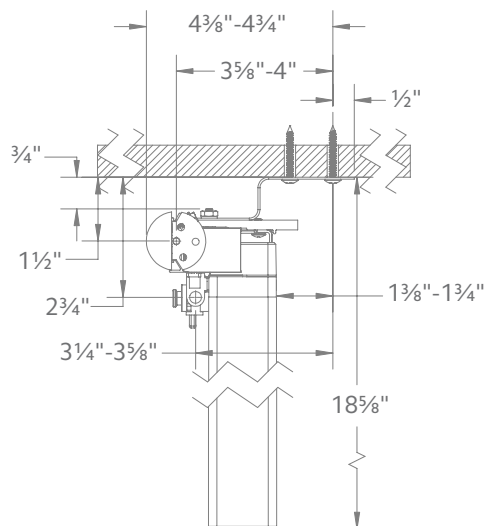

2" CEILING MOUNT

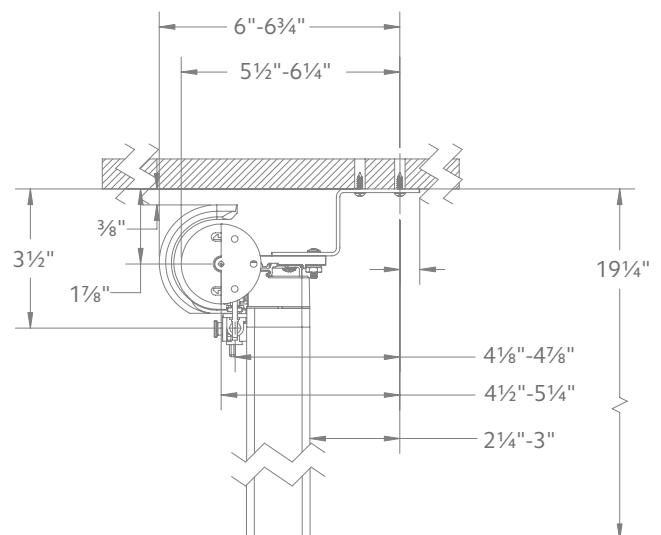

USING 94125xxx, 1796061 and 94130xxx

1 3/8" DOUBLE MOUNT

2" DOUBLE MOUNT

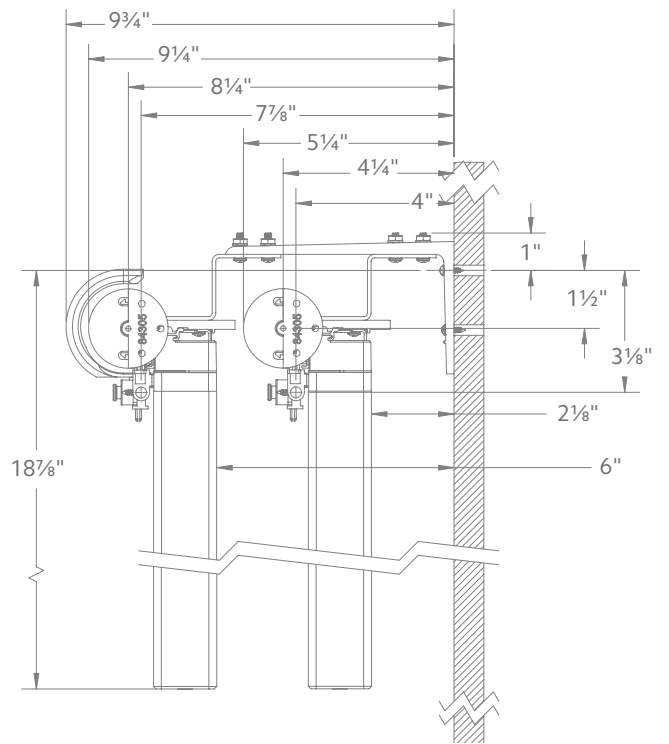
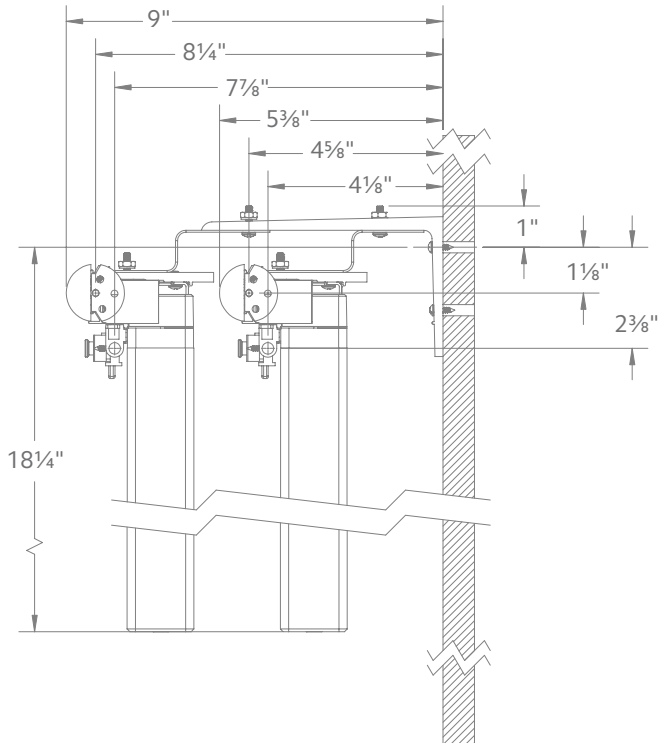

USING 94125xxx, 1796061 and 94130xxx

2" & 1 3/8" DOUBLE MOUNT

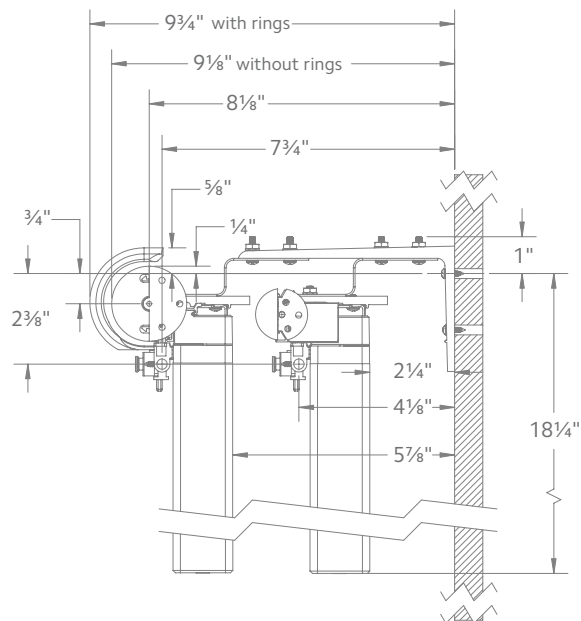



Kirsch® is proud to extend a 10 year warranty on all Kirsch® Drapery Hardware products manufactured after July 1, 2018 using all Kirsch® components. This is part of our commitment to providing the highest quality products, which has been our continued tradition since 1907.

COVERED

by a 10 year warranty

- Kirsch® Drapery Hardware products are covered for defects in materials, workmanship or failure to operate for 10 years from the date of purchase (unless shorter periods are provided below), provided that the original retail purchaser continues to own the product.
- All internal mechanisms.
- Components, brackets and operational cords.
- Operational cords for a full 7 years from the date of purchase.
- Repairs and/or replacements will be made with like or similar parts or products. Style, color or components may vary depending on original purchase date.
- Kirsch® motorization components are covered for 5 years from the date of purchase.

NOT COVERED

by a 10 year warranty

- Any conditions caused by normal wear and tear.
- Abuse, accidents, misuse or alterations to the product.
- Exposure to the elements (sun damage, wind, water/moisture, salt air) and discoloration or fading over time.
- Normal maintenance associated with motors and related accessories including, but not limited to, recharging and replacement of batteries.
- Failure to follow our instructions with respect to measurement, proper installation, cleaning or maintenance.
- Shipping charges, cost of removal and reinstallation.

Kirsch® (or its licensed fabricators/distributor) will repair or replace the product or components found to be defective.

TO OBTAIN WARRANTY SERVICE

- Contact your original dealer (place of purchase) for warranty assistance.
- Contact Kirsch® at (800) 252-2512 for technical support, certain parts free of charge, for assistance in obtaining warranty service or for further explanation of our warranty.

NOTE: In no event shall Kirsch® or its licensed fabricators/distributor be liable or responsible for incidental or consequential damages or for any other indirect damage, loss, cost or expense. Some states do not allow the exclusion or limitation of incidental or consequential damages, so the above exclusion or limitation may not apply to you. This warranty gives you specific legal rights, and you may also have other rights which vary from state to state.

Different warranty periods and terms apply for commercial products and applications.



Midwest
Designer
Supply

1-888-523-2611

**Midwest Designer Supply, Inc.
N30W22377 Green Road Ste C
Waukesha, WI 53186
(262) 523-2600
Fax (262) 524-1007
www.midwestdesignersupply.com**

MDS - your one source for window fashions.

 KIRSCH®

Buckingham®
redefining luxury

Designer Metals™
inspiring brilliance

Wood Trends™
renewing traditions

Wrought Iron
forging artistry

**Custom Rodding
& Basic Hardware**
unique solutions